



maxema®

ANTIBACTERIAL
PENS

CATALOGUE 2021



Made
in Italy



Prodotto
in Italia



Fabriqué
en Italie



Fabricado
en Italia

Contents

Indice

More than plastic.	07
Maxema Recycled Antibacterial Pens 	09
Tag Green Antibacterial  	14
twist-action / meccanismo a rotazione TA2-C AB RE	16
Icon Green Antibacterial  	18
twist-action / meccanismo a rotazione IG2-C AB RE	20
Maxema Antibacterial Pens 	22
Dot – Antibacterial 	28
retractable / meccanismo a scatto D1-MATT CB AB	
Flow Pure – Antibacterial 	30
twist-action / meccanismo a rotazione F2P-C AB	
Zink – Antibacterial 	31
twist-action / meccanismo a rotazione Z1-C AB	
Pixel – Antibacterial 	32
retractable / meccanismo a scatto PX40-MATT CB AB	
Bay – Antibacterial 	33
twist-action / meccanismo a rotazione B500-C AB	

Technical information informazioni tecniche	34
Packaging	44
Sales support supporti di vendita	48
Inks and refills inchiostri e refill	51
Pantone codes Codici Pantone	52

More than plastic.

EN

Those who know us are well aware that our pens are much more than just plastic. We have been working in Italy for two generations alongside people we trust and with whom we love to design top quality writing implements. Each Maxema pen is created from the desire to take care of the environment and our customers, with safe, reliable and durable materials. Our mission? To support your projects and help you, wherever you may be in the world, to tell your story and leave a lasting message.

IT

Chi ci conosce lo sa bene, le nostre penne sono molto più che semplice plastica. Da oltre due generazioni lavoriamo in Italia a fianco di persone di cui ci fidiamo e con le quali amiamo creare strumenti di scrittura di altissima qualità.

Ogni penna Maxema nasce dalla voglia di prenderci cura dell'ambiente e dei nostri clienti, con materiali sicuri, affidabili e duraturi. La nostra missione? Sostenere i tuoi progetti e aiutarti, in qualsiasi parte del mondo, a raccontare la tua storia e lasciare un messaggio che duri nel tempo.



RECYCLED ANTIBACTERIAL
PENS

NEW

Safety meets sustainability:
discover our recycled plastic
antibacterial pens with the
Jumbo refill designed to last
even longer.

—
*La sicurezza incontra
la sostenibilità: scopri le
nostre penne antibatteriche
in plastica riciclata, con il
refill Jumbo pensato per
durare ancora più a lungo.*

Doppia protezione,
per te e per l'ambiente

DOUBLE PROTECTION, FOR YOU AND THE ENVIRONMENT



EN

Maxema's new antibacterial pens are made from recycled plastic deriving 100% from European post-consumer products, to which a special additive is added that destroys up to 99.99% of bacteria.

IT

Le nuove penne antibatteriche Maxema sono realizzate in plastica riciclata derivante al 100% da prodotti post-consumo europei, a cui viene aggiunto uno speciale additivo che distrugge fino al 99,99% dei batteri.



Una penna sostenibile
e duratura

NEW

A SUSTAINABLE AND DURABLE PEN

EN

Recycled plastic, Jumbo refill and silver ions:
the right combination for safe living, having more ink
to write with and for saving the planet.









IT

Plastica riciclata, refill Jumbo e ioni d'argento:
la combinazione giusta per vivere in modo sicuro,
avere più inchiostro per scrivere e salvaguardare
il pianeta.

La sicurezza,
in tutte le sue sfumature

SAFETY, IN ALL ITS NUANCES

solid / coprenti

06		ICE	10		CLOUD
76		DESERT	87		MUD
19		FOREST	21		ABYSS
58		GRAPHITE	07		ONYX

Tag Green Antibacterial

△ RECYCLED

Objective: total safety.
Obiettivo: sicurezza totale.

Design that combines safety and environment friendliness.

Il design sposa la sicurezza e rispetta l'ambiente.

NEW

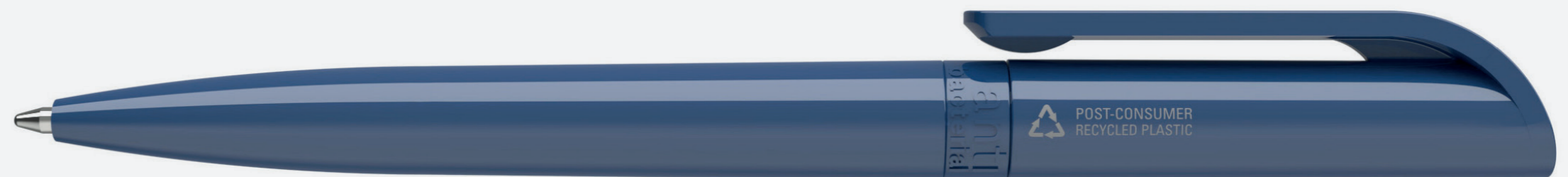

QUALITY NOT QUANTITY

The entire Maxema collection is available in recycled plastic on request /
Tutta la collezione Maxema è realizzabile in plastica riciclata su richiesta

Technical information at p. 36
Informazioni tecniche a pag. 36

Recycled antibacterial plastic
Solid colours with glossy finish

Recycled
and antibacterial:
the new plastic
that takes care
of you and
the environment

NEW

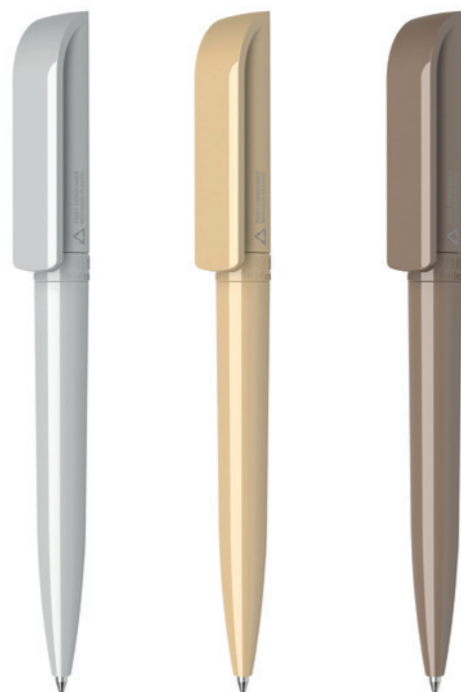

10 76 87

06 ice / pad printing 35 x 7 mm
tampografia 35 x 7 mm

Plastica riciclata antibatterica
Colori coprenti con finitura lucida

Riciclata
e antibatterica:
la nuova plastica
che si prende
cura di te
e dell'ambiente



19 21 58 07



MY BOX RECYCLED

Universal reclosable single pen box
in recycled Fedrigoni paper.
Info at p. 44

*Astuccio universale richiudibile per penna
singola in cartoncino riciclato Fedrigoni.
Info pag. 44*

Icon Green Antibacterial

△ RECYCLED

People and environment friendly.
Nel rispetto dell'uomo e della natura.

Testimony of an
enduring message.

*Testimone di un
messaggio destinato
a durare nel tempo.*

NEW

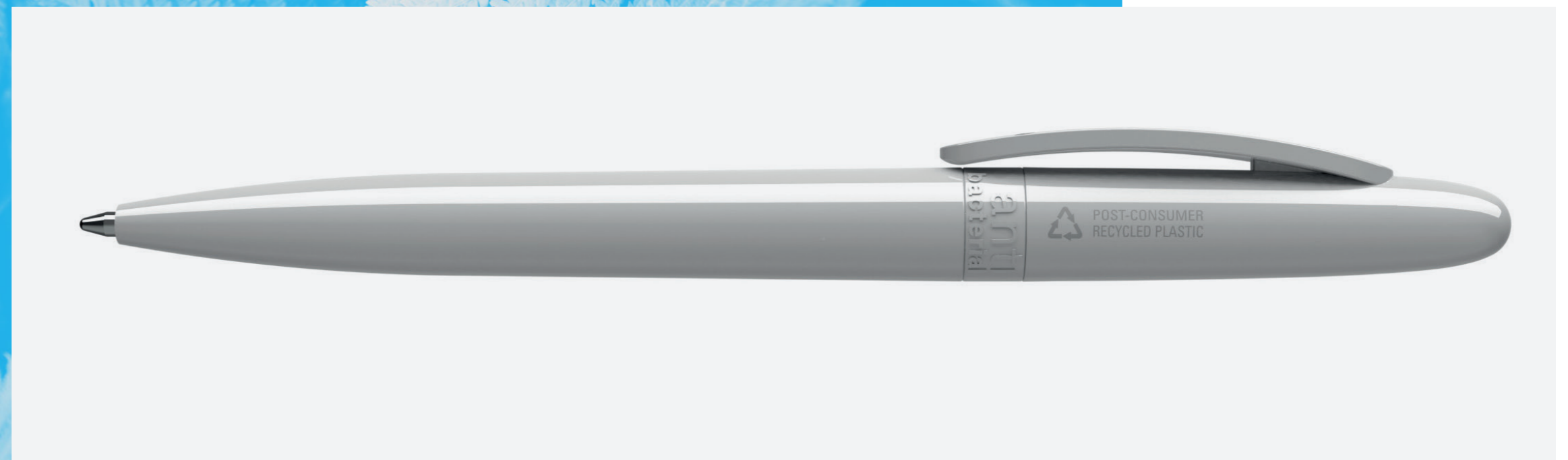

QUALITY NOT QUANTITY

The entire Maxema collection is available in recycled plastic on request /
Tutta la collezione Maxema è realizzabile in plastica riciclata su richiesta

Technical information at p. 37
Informazioni tecniche a pag. 37

Recycled antibacterial plastic
Solid colours with glossy finish

NEW



06



76



87

10 cloud / screen printing 40 x 30 mm
serigrafia 40 x 30 mm

Plastica riciclata antibatterica
Colori coprenti con finitura lucida



19



21



58



07



MY BOX RECYCLED

Universal reclosable single pen box
in recycled Fedrigoni paper.
Info at p. 44

*Astuccio universale richiudibile per penna
singola in cartoncino riciclato Fedrigoni.
Info pag. 44*



TAKE IT
SAFE,
TAKE IT
EASY.

ANTIBACTERIAL PENS

NEW

Take care of yourself even when you write: the plastic we use for our Antibacterial collection prevents bacteria from settling on pen surfaces and passing from one hand to the other.

—
*Anche quando scrivi,
prenditi cura di te:
la plastica che usiamo
per la nostra collezione
Antibacterial impedisce
ai batteri di depositarsi
sulle superfici della penna
e passare da una mano
all'altra.*

Solo penne, niente batteri

NEW

JUST PENS, NO BACTERIA.

EN

We need to feel protected, every day and today even more so. Maxema Antibacterial is our new collection of antibacterial pens, able to combine design and safety. Due to a special ISO 22196:2011 certified antimicrobial additive, the plastic releases silver ions that destroy up to 99,99% of the bacteria present on the pen.

Take it safe, take it easy

In the office, at the bar, in public places: has it ever crossed your mind how many microbes pass from hand to hand through the most everyday actions? Our antibacterial pens, combined with good hygiene habits, guarantee an additional level of protection.

IT

Abbiamo bisogno di sentirci protetti, ogni giorno e oggi ancora di più. Maxema Antibacterial è la nostra nuova collezione di penne antibatteriche, in grado di unire design e sicurezza. La plastica, grazie a uno speciale additivo antimicrobico certificato ISO 22196:2011, rilascia ioni d'argento che distruggono fino al 99,99% dei batteri presenti sulla penna.

Solo penne, niente batteri

In ufficio, al bar, nei luoghi pubblici: hai mai pensato a quanti microbi passano di mano in mano attraverso i gesti più quotidiani? Le nostre penne antibatteriche, abbinata a buone abitudini igieniche, garantiscono un ulteriore livello di protezione.

TAKE IT
SAFE,
TAKE IT
EASY.

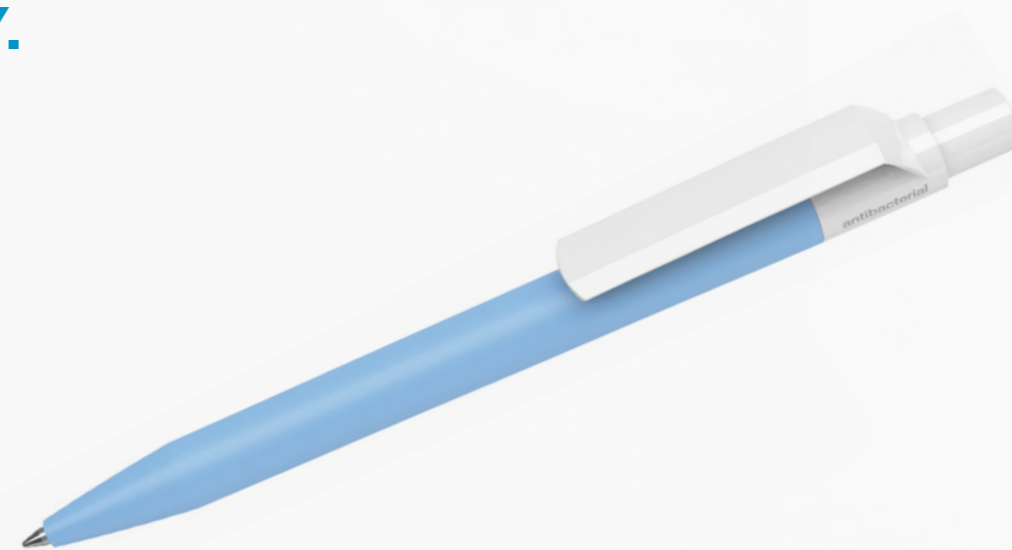

NEW

WHY CHOOSE MAXEMA ANTIBACTERIAL



EN

The plastic used is antibacterial

A special ISO 22196:2011 certified antimicrobial additive releases silver ions and prevents bacteria from settling on the surfaces of the pen.

IT

La plastica è antibatterica

Uno speciale additivo antimicrobico certificato ISO 22196:2011 rilascia ioni d'argento e impedisce ai batteri di depositarsi sulle superfici della penna.



Bacteria: up to 99,99% less

Laboratory tests have shown that up to 99,99% of the bacteria on the pen are destroyed.

Batteri: fino al 99,99% in meno

I test condotti in laboratorio dimostrano che i batteri presenti sulla penna vengono distrutti fino al 99,99%.



We care about your health

Some bacteria can cause disease and infections: make your life still safer, even when you write.

Abbiamo a cuore la tua salute

Alcuni batteri possono causare malattie e infezioni: rendi la tua vita ancora più sicura, anche quando scrivi.

SILVER IONS ELIMINATE UP TO 99,99% OF BACTERIA

EN

A special ISO 22196:2011 certified additive that releases silver ions is added to the ABS plastic we use for our Antibacterial pens: the ions settle on the cell walls of bacteria and inhibit their survival and reproduction. The antibacterial effectiveness is confirmed by meticulous evaluation tests.

Microorganisms are inoculated in a sample of material and the surface is covered with a fine sterile film that promotes the spread of the bacteria, prevents evaporation and ensures contact with the antimicrobial surface.

After incubating for 24 hours at 37°C, the microbe concentrations are measured, and the reduction in microorganisms compared to the initial concentrations calculated. The 99,99% reduction in bacteria results in a good antimicrobial effect.

IT

Alla plastica ABS che usiamo per le nostre penne Antibacterial viene aggiunto un particolare additivo antimicrobico certificato ISO 22196:2011 che rilascia ioni d'argento: questi si depositano sulle pareti cellulari dei batteri e ne inibiscono la sopravvivenza e la riproduzione. L'efficacia antibatterica è confermata da accurati test di valutazione.

Su un campione di materiale vengono inoculati i microrganismi e la superficie viene coperta con una sottile pellicola sterile che favorisce la diffusione batterica, ne impedisce l'evaporazione e garantisce il contatto con la superficie antimicrobica.

Dopo l'incubazione per 24 ore a 37°C, vengono misurate le concentrazioni microbiche, calcolando la riduzione dei microrganismi rispetto alle concentrazioni iniziali. La riduzione del 99,99% dei batteri determina un buon effetto antimicrobico.

Test organisms / Organismi di prova	Bacteriostatic activity R / Attività batteriostatica R	Percentage reduction / Riduzione percentuale	Evaluation / Valutazione
Staphylococcus aureus (ATCC 33592)	1	up to 99,99% / fino al 99,99%	Good antimicrobial effect / Buon effetto antimicrobico

DOT ANTIBACTERIAL
D1-MATT CB AB

Antibacterial plastic, solid colour barrel with matt finish, solid glossy white clip, push-button and little sphere

NEW



01



15 red / pad printing 40 x 9 mm
15 rosso / tampografia 40 x 9 mm

25 dark violet / pad printing 40 x 9 mm
25 viola scuro / tampografia 40 x 9 mm



Plastica antibatterica, fusto in colore coprente con finitura satinata, clip, tappino e piccola sfera in colore bianco coprente lucido

solid / coprenti

01 white bianco	03 yellow giallo	18 orange arancio	15 red rosso
74 burgundy bordeaux	60 pink rosa	61 magenta magenta	71 light violet viola chiaro
25 dark violet viola scuro	79 lime lime	09 green verde	75 dark green verde scuro
26 aquamarine acquamarina	27 ocean green ottanio	64 pastel blue azzurro pastello	77 cyan ciano
12 light blue azzurro	22 blue blu	05 grey grigio	04 black nero

Technical information at p. 39
Informazioni tecniche a pag. 39

FLOW PURE ANTIBACTERIAL F2P-C AB

Antibacterial plastic, solid white colour
with glossy finish

–
*Plastica antibatterica, colore bianco
coprente con finitura lucida*

NEW



01

solid / coprenti

01
white
bianco

Technical information at p. 38
Informazioni tecniche a pag. 38

ZINK ANTIBACTERIAL Z1-C AB

Antibacterial plastic, solid white colour
with glossy finish

–
*Plastica antibatterica, colore bianco
coprente con finitura lucida*

NEW



01

solid / coprenti

01
white
bianco

Technical information at p. 40
Informazioni tecniche a pag. 40

PIXEL ANTIBACTERIAL PX40-MATT CB AB

Antibacterial plastic, solid white colour
barrel with matt finish, solid glossy
white clip and push-button

–
*Plastica antibatterica, fusto in colore
bianco coprente con finitura
satinata, clip e tappino in colore
bianco coprente lucido*

NEW



01



solid / coprenti

01

white
bianco

Technical information at p. 41
Informazioni tecniche a pag. 41

BAY ANTIBACTERIAL B500-C AB

Antibacterial plastic, solid white colour
with glossy finish

–
*Plastica antibatterica, colore bianco
coprente con finitura lucida*

NEW



01



solid / coprenti

01

white
bianco

Technical information at p. 42
Informazioni tecniche a pag. 42

Technical information
Informazioni tecniche

Tag green Recycled Antibacterial

NEW

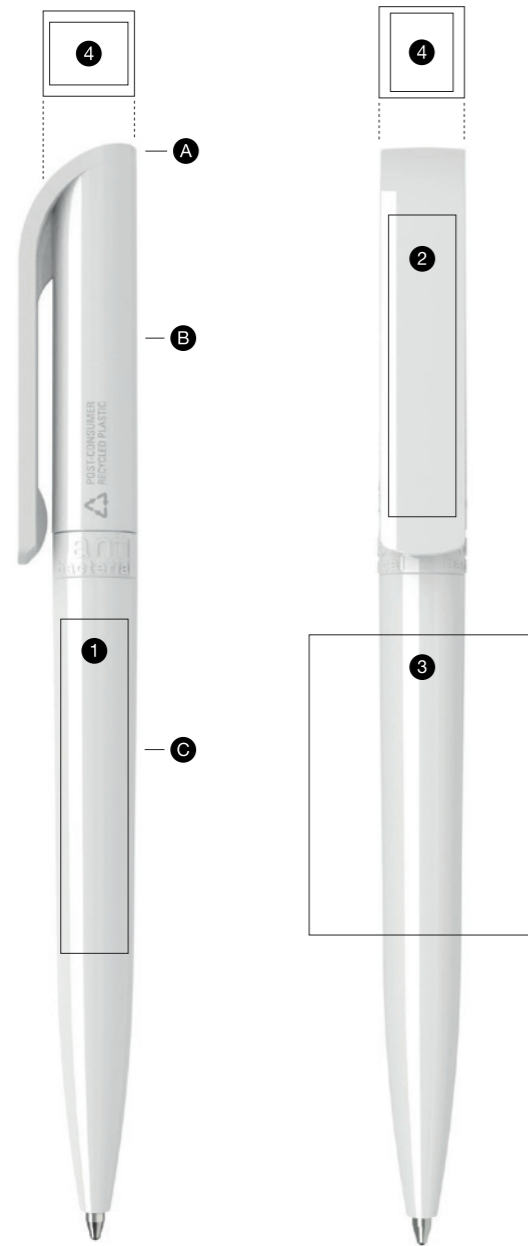

Components / Componenti

- A Plug / tassello
- B Clip / clip
- C Barrel / fusto

Print area / Area stampabile

- 1 pad printing / tampografia 45 x 9 mm
- 2 pad printing / tampografia 40 x 9 mm
- 3 screen printing / serigrafia 40 x 30 mm
- 4 pad printing / tampografia 8 x 10 mm

Features / Caratteristiche

twist-action / meccanismo a rotazione

recycled plastic derived from post-consumer products, certified and compliant with RoHS and REACH regulations / plastica riciclata derivante da prodotti post-consumo certificata e conforme alle normative RoHS e REACH.

ISO 22196:2011 certified antimicrobial additive / additivo antimicrobico certificato ISO 22196:2011

Jumbo refill, blue and black ink / refill Jumbo, inchiostro blu e nero

available in glossy finish / disponibile con superfici lucide

TA2 - RECYCLED PLASTIC
PLASTICA RICICLATA

Small imperfections and slight colour variations are to be considered intrinsic features of the recycled material deriving from the post consumer sector. / Piccole imperfezioni e lievi variazioni cromatiche sono da considerarsi caratteristiche intrinseche del materiale riciclato derivante dal post-consumo.

Icon green Recycled Antibacterial

NEW

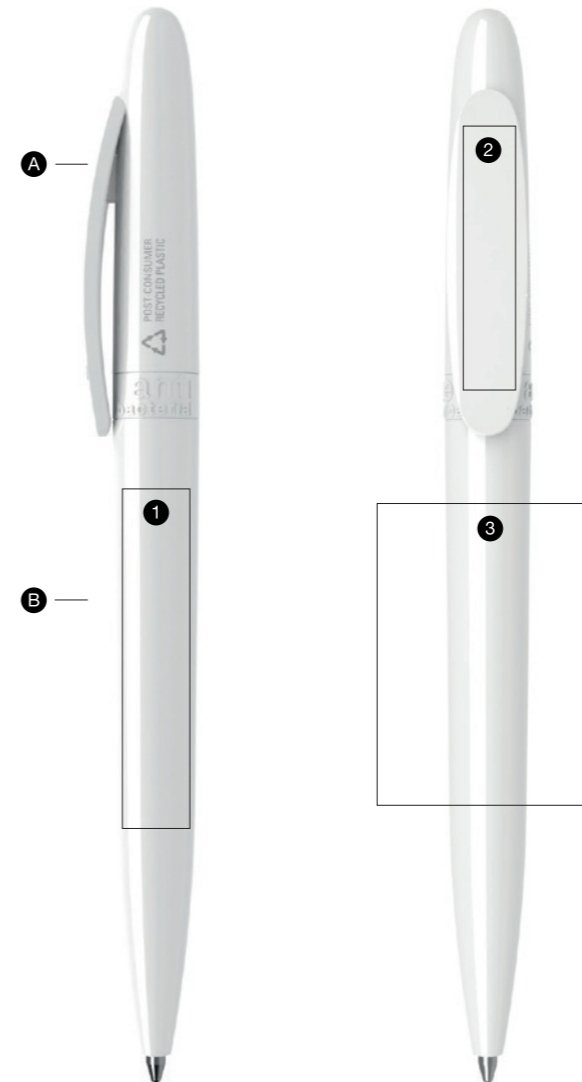

Components / Componenti

- A Cap / cappuccio
- B Barrel / fusto

Print area / Area stampabile

- 1 pad printing / tampografia 45 x 9 mm
- 2 pad printing / tampografia 35 x 7 mm
- 3 screen printing / serigrafia 40 x 30 mm

Features / Caratteristiche

twist-action / meccanismo a rotazione

recycled plastic derived from post-consumer products, certified and compliant with RoHS and REACH regulations / plastica riciclata derivante da prodotti post-consumo certificata e conforme alle normative RoHS e REACH.

ISO 22196:2011 certified antimicrobial additive / additivo antimicrobico certificato ISO 22196:2011

Jumbo refill, blue and black ink / refill Jumbo, inchiostro blu e nero

available in glossy finish / disponibile con superfici lucide

IG2 - RECYCLED PLASTIC
PLASTICA RICICLATA

Small imperfections and slight colour variations are to be considered intrinsic features of the recycled material deriving from the post consumer sector. / Piccole imperfezioni e lievi variazioni cromatiche sono da considerarsi caratteristiche intrinseche del materiale riciclato derivante dal post-consumo.

Flow Pure

NEW

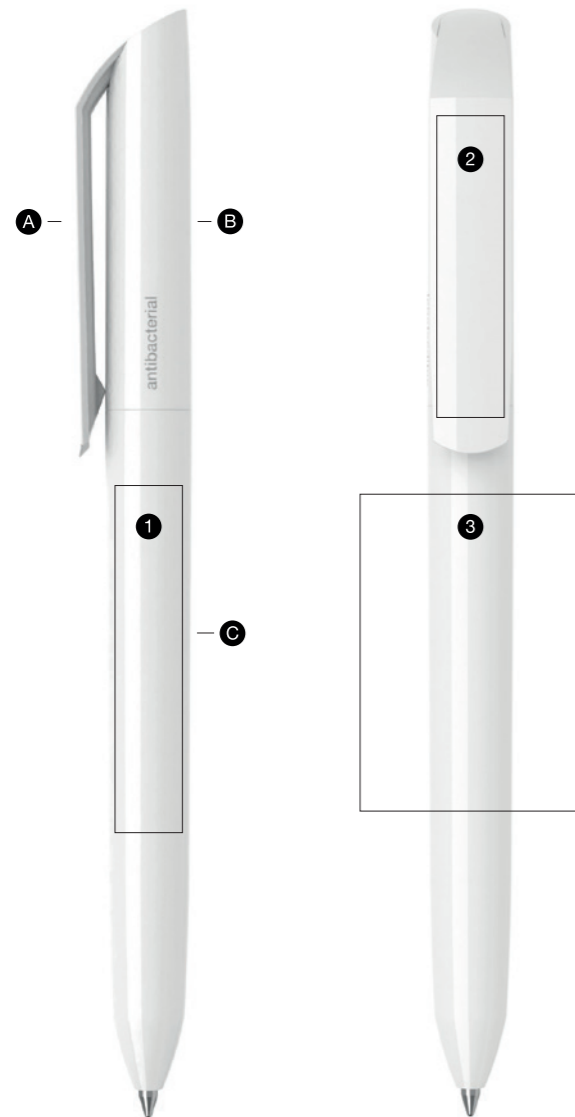

Components / Componenti

- A Clip
- B Cap / cappuccio
- C Barrel / fusto

Print area / Area stampabile

- 1 pad printing / tampografia
50 x 9 mm
- 2 pad printing / tampografia
40 x 9 mm
- 3 screen printing / serigrafia
45 x 30 mm

Features / Caratteristiche

twist-action / meccanismo a rotazione

made of antibacterial ABS plastic with a special ISO 22196:2011 certified antimicrobial additive / realizzata in plastica ABS antibatterica con speciale additivo antimicrobico certificato ISO 22196:2011

Jumbo refill, blue and black ink / refill Jumbo, inchiostro blu e nero

available in glossy finish / disponibile con superfici lucide

Fast Dry Gel blue and black ink available on request /
Refill Gel Fast Dry blu e nero disponibile su richiesta

Dot

NEW

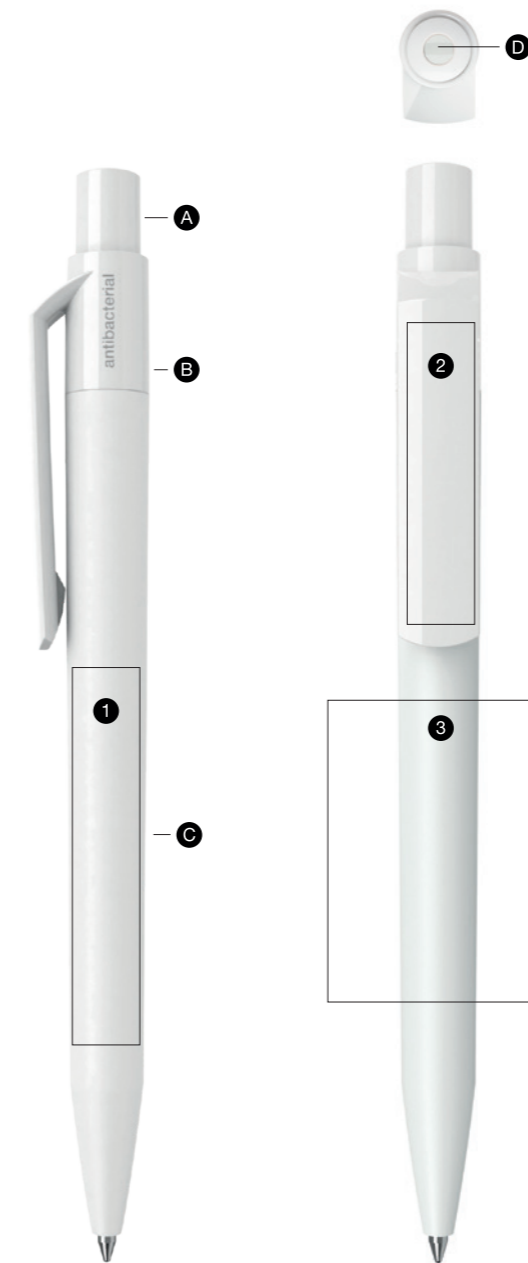

Components / Componenti

- A Push-button / tappino
- B Clip
- C Barrel / fusto
- D Little sphere / piccola sfera

Print area / Area stampabile

- 1 pad printing / tampografia
50 x 9 mm
- 2 pad printing / tampografia
40 x 9 mm
- 3 screen printing / serigrafia
40 x 30 mm

Features / Caratteristiche

retractable with return spring / meccanismo a scatto, con molla di ritorno

made of antibacterial ABS plastic with a special ISO 22196:2011 certified antimicrobial additive / realizzata in plastica ABS antibatterica con speciale additivo antimicrobico certificato ISO 22196:2011

Jumbo refill, blue and black ink / refill Jumbo, inchiostro blu e nero

available in glossy and matt finish / disponibile con superfici lucide e satinare

Fast Dry Gel blue and black ink available on request /
Refill Gel Fast Dry blu e nero disponibile su richiesta

Zink

NEW

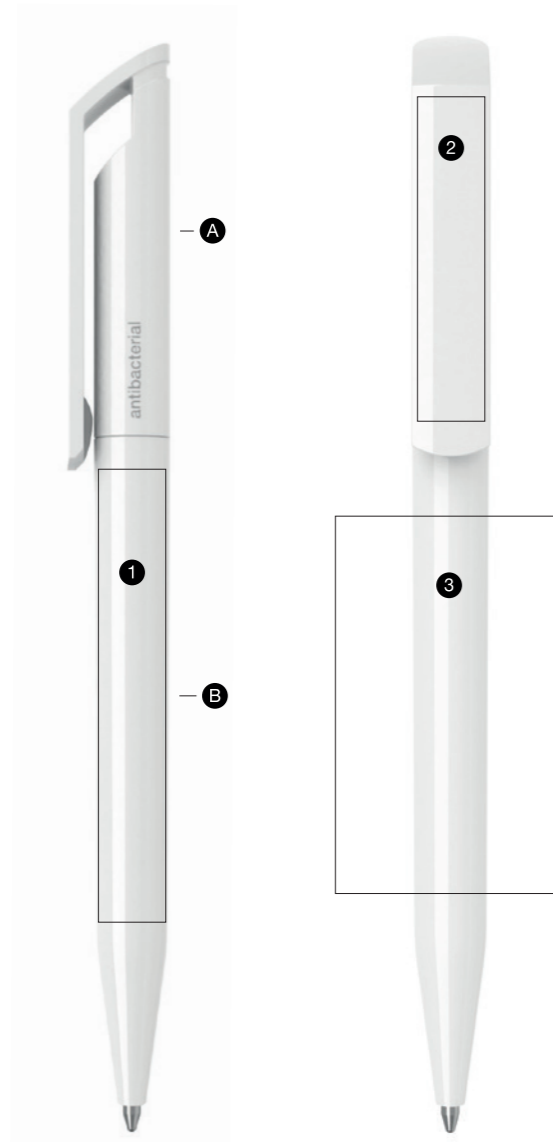

Components / Componenti

- A Cap / cappuccio
- B Barrel / fusto

Print area / Area stampabile

- 1 pad printing / tampografia
60 x 9 mm
- 2 pad printing / tampografia
43 x 9 mm
- 3 screen printing / serigrafia
50 x 30 mm

Features / Caratteristiche

twist-action / meccanismo a rotazione

made of antibacterial ABS plastic with a special ISO 22196:2011 certified antimicrobial additive / realizzata in plastica ABS antibatterica con speciale additivo antimicrobico certificato ISO 22196:2011

Jumbo refill, blue and black ink / refill Jumbo, inchiostro blu e nero

available in glossy finish / disponibile con superfici lucide

Fast Dry Gel blue and black ink available on request /
Refill Gel Fast Dry blu e nero disponibile su richiesta

Pixel

NEW

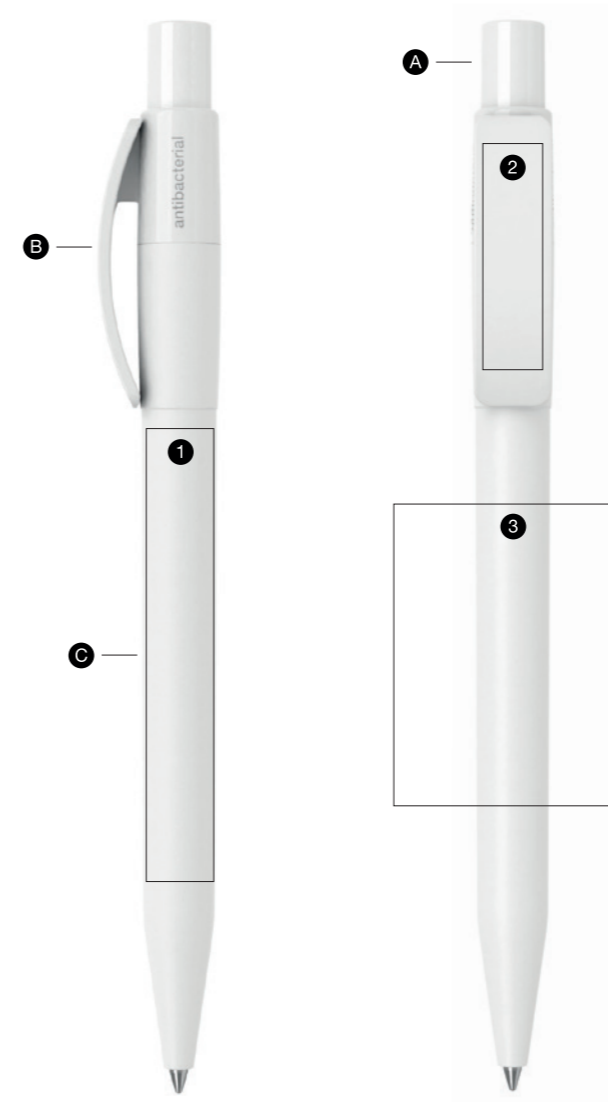

Components / Componenti

- A Push-button / tappino
- B Clip
- C Barrel / fusto

Print area / Area stampabile

- 1 pad printing / tampografia
60 x 9 mm
- 2 pad printing / tampografia
30 x 8 mm
- 3 screen printing / serigrafia
40 x 31 mm

Features / Caratteristiche

retractable / meccanismo a scatto

ventilated push-button / tappino ventilato

made of antibacterial ABS plastic with a special ISO 22196:2011 certified antimicrobial additive / realizzata in plastica ABS antibatterica con speciale additivo antimicrobico certificato ISO 22196:2011

X-20 refill, blue and black ink / refill X 20, inchiostro blu e nero

the barrel is available in matt finish, the clip and the push-button are available in glossy finish / il fusto è disponibile con superfici satinata, la clip e il tappino sono disponibili con superfici lucide

Fast Dry Gel blue and black ink available on request /
Refill Gel Fast Dry blu e nero disponibile su richiesta

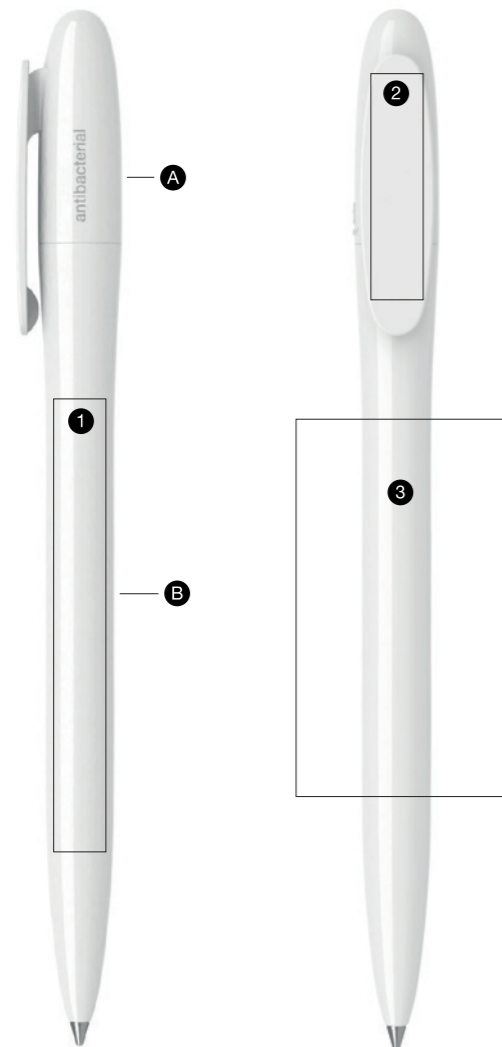

Components / Componenti

- A Cap / cappuccio
- B Barrel / fusto

Print area / Area stampabile

- 1 pad printing / tampografia
60 x 7 mm
- 2 pad printing / tampografia
30 x 7 mm
- 3 screen printing / serigrafia
50 x 28 mm

Features / Caratteristiche

twist-action / meccanismo a rotazione

made of antibacterial ABS plastic with a special ISO 22196:2011 certified antimicrobial additive / realizzata in plastica ABS antibatterica con speciale additivo antimicrobico certificato ISO 22196:2011

X-20 refill, blue and black ink / refill X-20, inchiostro blu e nero

available in glossy finish / disponibile con superfici lucide

Fast Dry Gel blue and black ink available on request /
Refill Gel Fast Dry blu e nero disponibile su richiesta

Sales support *Supporti di vendita*

Inks and refills *Inchiostri e refill*

Packaging

MY BOX — RECYCLED



Una penna in plastica riciclata
si merita un packaging eco-friendly.

A RECYCLED PLASTIC PEN DESERVES ECO-FRIENDLY PACKAGING.

Pad printing / tampografia

- ① 14,8 x 2 cm
- ② 14,9 x 2 cm
- ③ 14,8 x 2 cm
- ④ 14,8 x 2 cm

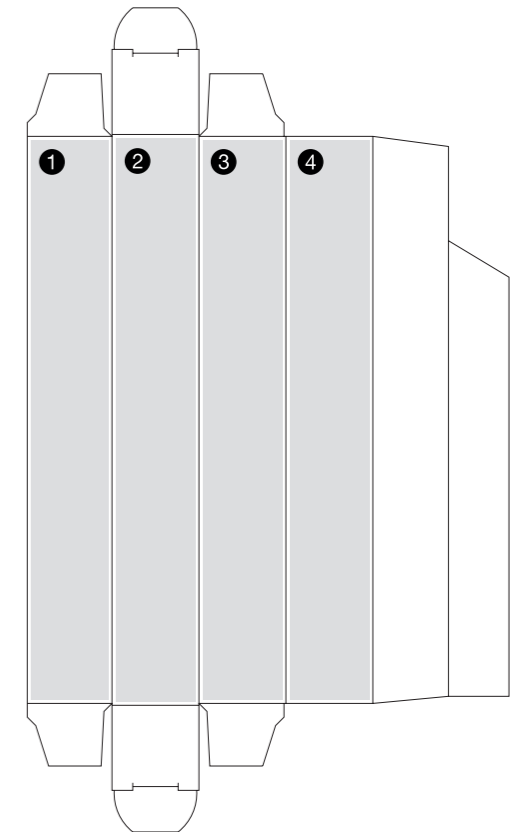

universal reclosable single pen case in Fedrigoni recycled paper Kraft, Clay and Ardesia 250 g/m² card, personalisable with pad printing

size: 2,3 x 15,1 x 2,3 cm

—
astuccio universale richiudibile per penna singola
in cartoncino Fedrigoni riciclato Kraft, Clay e Ardesia
250 g/m², personalizzabile con stampa tampografica

dimensioni: 2,3 x 15,1 x 2,3 cm

Packaging

MY CASE



Pad printing / tampografia

- ❶ 4,2 x 16,6 cm
- ❷ 4,3 x 14,8 cm

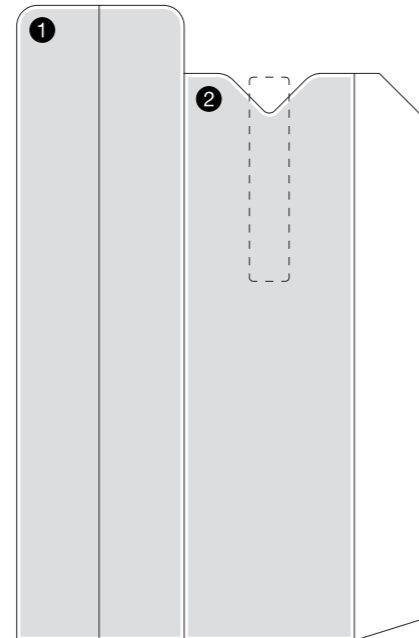

universal single pen case in
Fedrigoni Ultra Black 280 g/m² card,
personalisable with pad printing

size: 4,4 x 16,8 cm

—
*astuccio universale per penna singola
in cartoncino Fedrigoni Ultra Black 280
gr/m², personalizzabile con stampa
tampografica*

dimensioni: 4,4 x 16,8 cm

MY BOX



Pad printing / tampografia

- ❶ 14,8 x 2 cm
- ❷ 14,9 x 2 cm
- ❸ 14,8 x 2 cm
- ❹ 14,8 x 2 cm

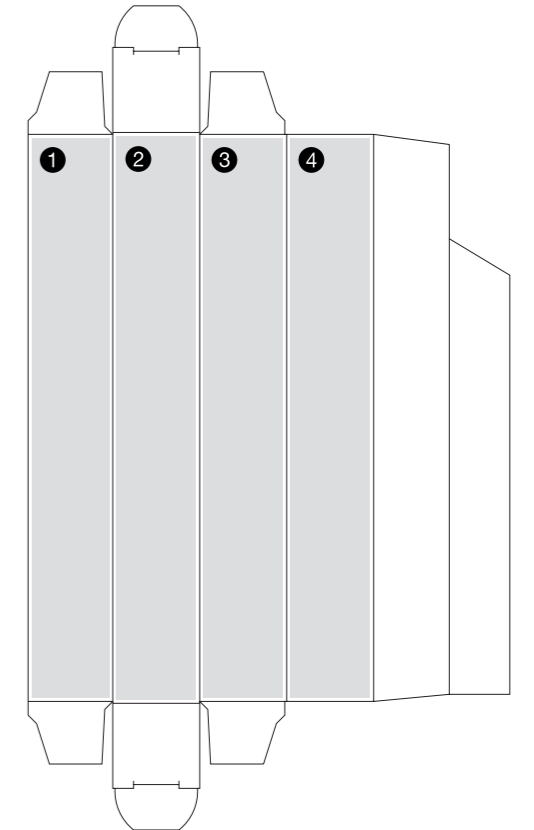

universal reclosable single pen case in
Fedrigoni Ultra Black 280 g/m² card,
personalisable with pad printing

size: 2,3 x 15,1 x 2,3 cm

—
*astuccio universale richiudibile per
penna singola in cartoncino Fedrigoni
Ultra Black 280 gr/m², personalizzabile
con stampa tampografica*

dimensioni: 2,3 x 15,1 x 2,3 cm

Minikit

ANTIBACTERIAL



Monochromatic presentation of the Antibacterial collection: white has always been a symbol of safety and protection.

Presentazione monocromatica della collezione Antibacterial: il bianco è da sempre simbolo di sicurezza e protezione.

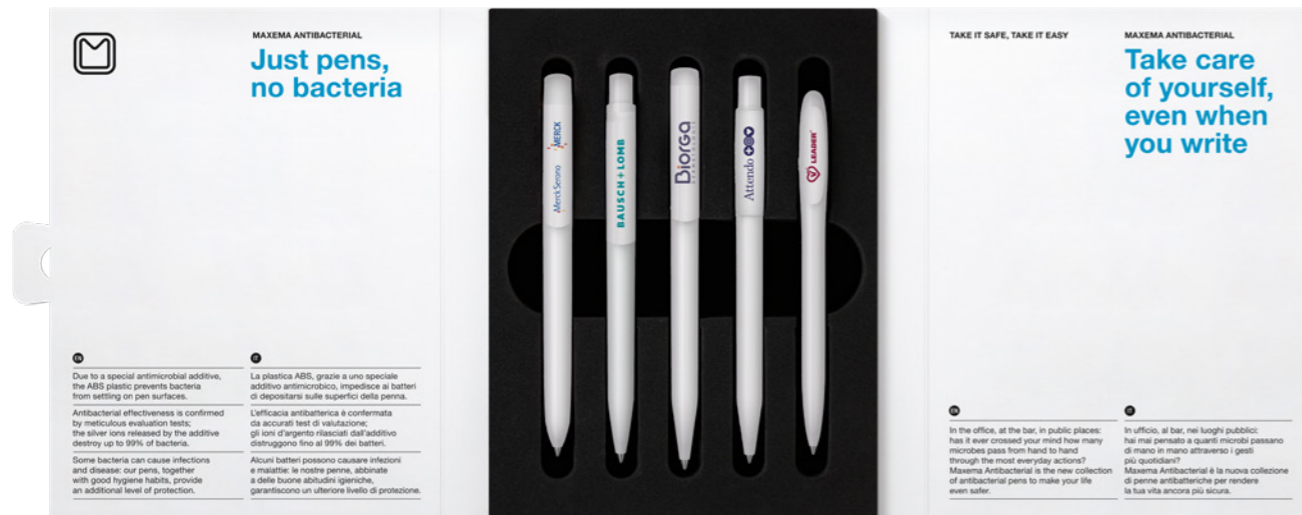

5 antibacterial printed pens in white colour

size: 10,2 x 19 cm (closed format)

—
5 penne antibatterica bianche

dimensioni: 10,2 x 19 cm (formato chiuso)

Minikit

8 RECYCLED ANTIBACTERIAL PENS



For our recycled antibacterial plastic pens samples we have chosen sustainable packaging made up of cellulose, certified recycled fibres and cotton fibres. FSC certification guarantees that the entire wood-paper supply chain derives from environmentally friendly, socially useful and economically sustainable forest management.

Per i campionari delle nostre penne in plastica antibatterica riciclata abbiamo scelto un packaging sostenibile composto da cellulosa, fibre di riciclo certificate e fibre di cotone. La certificazione FSC garantisce che l'intera filiera legno-carto derivi da una gestione forestale rispettosa dell'ambiente, socialmente utile ed economicamente sostenibile.

contains 8 recycled antibacterial pens of one model, in all available colours

size: 24,3 x 20 cm (closed format)

—
contiene 8 penne in plastica antibatterica riciclata di un modello, in tutti i colori disponibili

dimensioni: 24,3 x 20 cm (formato chiuso)

Kit Dot Antibacterial



Contains 20 printed Dot antibacterial in assorted colours

size: 25 x 34 cm (closed format)

—
 Contiene 20 penne Dot in plastica antibatterica stampate in colori assortiti

dimensioni: 25 x 34 cm (formato chiuso)

Inks and refills / Inchiostri e refill

INKS / INCHIOSTRI

● blue blu ● black nero

X-20



tungsten carbide ball Ø 1 mm, length 107 mm, for up to 2000 meters of writing
 sfera in carburo di tungsteno Ø 1 mm, lunghezza 107 mm, fino a 2000 metri di scrittura

The refill's barrel is made of polypropilene, the tip is made of nickel-plated brass. The non-toxic ink is Dokumental. All Dokumental inks comply with European REACH and American TSCA standards.

JUMBO



tungsten carbide ball Ø 1 mm, length 107 mm, for up to 2500 meters of writing
 sfera in carburo di tungsteno Ø 1 mm, lunghezza 107 mm, fino a 2500 metri di scrittura

—
 Il tubetto del refill è in polipropilene, la punta è in ottone nichelato. L'inchiostro, atossico, è Dokumental. Tutti gli inchiostri Dokumental sono conformi alla normativa europea REACH e americana TSCA.

RT 90 PARKER TYPE / TIPO PARKER



tungsten carbide ball Ø 0,8 mm, length 98 mm, for up to 4000 meters of writing
 sfera in carburo di tungsteno Ø 0,8 mm, lunghezza 98 mm, fino a 4000 metri di scrittura

The refill's barrel is made of polypropilene, the tip is made of nickel-silver brass. The non-toxic ink is Dokumental. All Dokumental inks comply with European REACH and American TSCA standards.

RT 90 ON DEMAND / SU RICHIESTA



tungsten carbide ball Ø 1 mm, length 98 mm, for up to 4000 meters of writing
 sfera in carburo di tungsteno Ø 1 mm, lunghezza 98 mm, fino a 4000 metri di scrittura

—
 Il tubetto del refill è in polipropilene, la punta è in nichel-silver. L'inchiostro, atossico, è Dokumental. Tutti gli inchiostri Dokumental sono conformi alla normativa europea REACH e americana TSCA.

GEL FAST DRY ON DEMAND / SU RICHIESTA



titanium carbide ball (SS, TC), Ø 0.7 mm, tip in stainless steel, length 98 mm, up to 700 meters of writing
 sfera in carburo di titanio (SS, TC) Ø 0,7 mm, punta in acciaio inox, lunghezza 98 mm, fino a 700 metri di scrittura

Water-based, non-toxic gel ink, produced in Italy and compliant with European REACH and American TSCA standards. The refill's barrel is made of polypropilene.

—
 Inchiostro gel a base acqua, atossico e prodotto in Italia, conforme alla normativa europea REACH e americana TSCA. Il tubetto del refill è in polipropilene.

Pantone codes / Codici Pantone

solid / coprenti

01	white / bianco	
03	yellow / giallo	pant 120
18	orange / arancio	pant 1505
15	red / rosso	pant 187
74	burgundy / bordeaux	pant 195
60	pink / rosa	pant 1905
61	magenta	pant 213
71	light violet / viola chiaro	pant 270
25	dark violet / viola scuro	pant violet
79	lime	pant 381
09	green / verde	pant 348
75	dark green / verde scuro	pant 3435
26	aquamarine / acquamarina	pant 3262
27	ocean green / ottanio	pant 321
64	pastel blue / azzurro pastello	pant 283
77	cyan / ciano	pant 2995
12	light blue / azzurro	pant 285
22	blue / blu	pant 287
05	grey / grigio	pant cool gray 6
04	black / nero	pant black 6

 RECYCLED PLASTIC PENS / PENNE IN PLASTICA RICICLATA

solid / coprenti

06	ice	
10	cloud	pant cool gray 1 C
76	desert	pant 466 C
87	mud	pant 7532 C
19	forest	pant 7735 C
21	abyss	pant 654 C
58	graphite	pant 425 C
07	onyx	

all rights reserved maxema srl
tutti i diritti riservati maxema srl

The brands mentioned in this catalogue are the exclusive property of the respective owners. They are used for purely illustrative purposes and cannot be the object of any buying and selling transactions, under any circumstances.

I marchi menzionati in questo catalogo sono di proprietà esclusiva dei rispettivi proprietari. L'utilizzo dei suddetti marchi è a puro titolo esemplificativo e non potrà mai, in alcun caso, essere oggetto di trattative commerciali.

Pantone colours are available on demand.
Please contact us to find out the minimum order quantity for each model.

I colori Pantone sono disponibili su richiesta, contattateci per conoscere i quantitativi minimi per ogni modello.

art direction and graphic design
undesign.it

still life
infinitostudio.com

editing
elena ambrosio
sara zampedri



Made
in Italy



Prodotto
in Italia



Fabriqué
en Italie



Fabricado
en Italia



maxema.com